

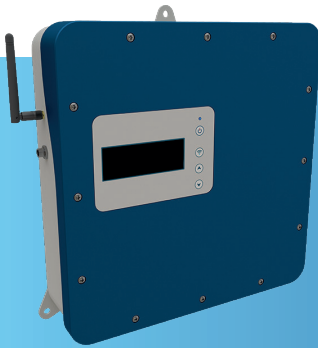

Water



GWF



Kanalis

Stationary ultrasonic area velocity flow meter for open channels

Your benefits

- Up to 10 acoustic measurement paths:
Exceptional accuracy, repeatability and linearity over the entire measurement range
- Highest-accuracy measurement:
Correct determination of flow using cross-sectional geometry, water level and velocity in accordance to ISO 6416.
- Automatic velocity profile approximation:
No need for time-consuming on-site calibration. Complex or varying flow behavior is accounted for
- Platform-independent web interface for configuration, operation and maintenance:
Easy and fast setup with multi-language graphical user interface. Parametrization with any mobile device, no software needed
- Integrated Wi-Fi access point and LAN interface, optional mobile connection:
Efficient system integration, real-time remote access anytime and anywhere

Application

- Open channels or closed conduits 1-20 m in width
- Ideal for applications under stationary non-uniform flow conditions (e.g. locks, gates and weirs)
- Permanent flow monitoring for applications in clean or slightly polluted water:
 - Rivers, ship channels
 - Irrigation channels
 - Industrial discharges
 - Wastewater treatment plants
 - Hydroelectric power plants

Features

- ABS wall-mounted transmitter, IP65 (NEMA 4)
- Ball-shaped transducers for channel widths of 1 to 20 m
- Compliant with ISO 6416
- Time of flight technology with digital signal processing
- Measurement in multiple planes with single or crossed paths
- Flow profile calculation in multipath systems, no on-site calibration needed
- Bi-directional measurement over the entire flow range
- Accuracy typically $\pm 2\%$ of measured flow value
- Measurement of low velocities down to 1.5 mm/s
- Integrated Wi-Fi access point
- Graphical user interface in multiple languages
- All units for display and data storage can be customized by the user
- Preselection of typical cross sections or user-definable irregular shapes
- Analog inputs for external level sensors
- Communication: RS-485, Modbus RTU/TCP, Ethernet, optional 4G/3G/2G
- Power supply: 9-36 V DC or 100-240 V AC (50/60 Hz)
- Internal data storage 16 GB

Options

- 1 to 10 acoustic measurement paths
- Optimized transducers for different path lengths
- Additional external level sensors (pressure, non-contact ultrasonic or radar)

Product description

Kanalis is an ultrasonic area velocity system designed for permanent flow monitoring in open channels or closed conduits. Kanalis is a fully integrated metering solution with up to 10 acoustic paths. It operates bidirectionally without causing obstruction or head loss.

Flow monitoring is very often mandatory in the area of water supply and industry. Flow is also a major input value for controlling the minimum ecological flow or to operate weirs and gates. Kanalis measures man-made channels, tunnels and aqueducts precisely in order to prevent long-term water losses and support process stability.

WebUI (Wi-Fi)

Kanalis is equipped with an integrated web server running a WebUI. You can display and manage the WebUI using the standard web browser of your smartphone, tablet PC or notebook. There is no need for any additional software or App. Parameter setting and data visualization has never been so easy.



Data storage and transmission

Combine the Kanalis with a 4G/3G/2G cellular modem for automatic data transmission. The logged data can be sent to any host computer (FTP server) or to the GWF web-based cloud solution at a user-selectable interval (e.g. 4 times a day, once a day or once a week). Alternatively, wireless LAN and Ethernet connections are available.

Information on level, velocity, flow and signal strength can be taken at regular intervals between 1 minute and 60 minutes. In case of a flood event, the logging can be set automatically to one minute (event mode). Kanalis is equipped with internal storage capacity (16 GB) and will store data for up to 18 months.

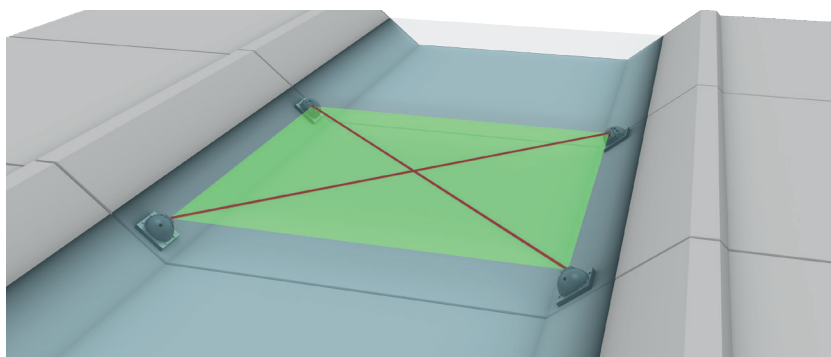

Crossed-path Kanalis system in irrigation channel

Measuring principle

Kanalis is an area velocity ultrasonic flow meter which uses the time of flight method. An ultrasonic pulse is sent with and against flow direction. The difference in signal travelling time (time of flight) is then evaluated. Combined with water level measurement and the cross-sectional area, Kanalis accurately determines flow over its entire measuring range.

Kanalis can measure in up to 10 acoustic paths, e.g. in five planes with two crossed paths each. Multi-path systems have several advantages:

1. Cross flows in channels may form due to conditions such as bends in the conduit. Although cross flows do not influence the total flow volume, they can affect the measurement accuracy. With a crosswise arrangement of four transducers, secondary flow effects can be eliminated.
2. When water levels in closed conduits are changing significantly, multiple paths ensure that the flow profile is measured consistently. With rising water level, more acoustic paths are activated. This system guarantees measurement accuracy at all times.
3. A system with acoustic paths layered on top of each other in parallel planes removes the need for a time-consuming hydrometric calibration.

For these reasons, the Kanalis system is suitable for applications with large water level fluctuations, reverse flow or a vertical velocity distribution outside the theoretical normal.

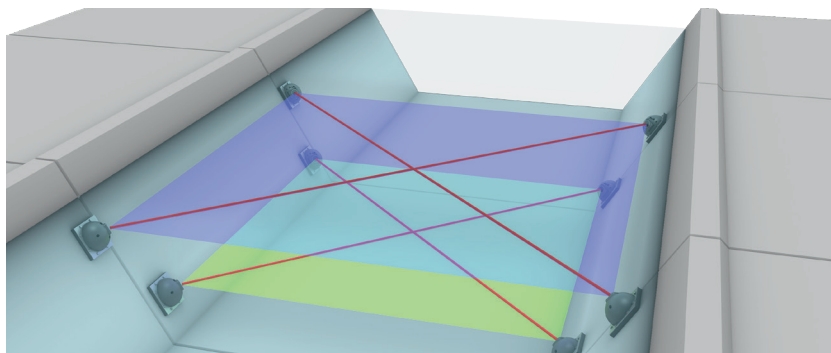

Multi-path Kanalis system with crossed paths in two planes

Component description

The Kanalis system is composed of a wall-mounted transmitter, two or more ultrasonic velocity sensors and any external level sensor (ultrasonic, radar or pressure).

Transmitter

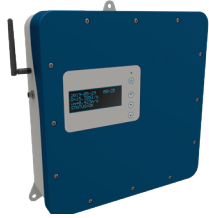

Wall-mounted transmitter

The Kanalis transmitter incorporates all the required algorithms and software to ensure measurement accuracy and repeatability. The IP65 (NEMA 4X) ABS housing features a 4 x 20 alphanumeric LCD display and a 4 button keypad.

All configuration data as well as measured and calculated data are stored inside a 16 GB MicroSD card. The transmitter controls the measurements, calculates the flow rate and provides freely programmable current outputs, status alarms, frequency outputs and totalizer readings.

Velocity sensors



TD-200/8 transducer

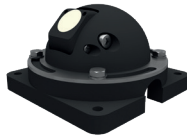

TD-200/18 transducer

The Kanalis sensors are mounted on the side of river, channel or conduit walls. The mounting from the side prevents aggregation of sediments on top of the sensor and enables easy installation and cleaning.

Standardized sensor mounting devices are available for any kind of channel geometry like rectangular, trapezoid or natural river banks. The flow optimized design protects the transducers against moving objects suspended in the flow stream. This method has proved its worth for applications in channels with high waste contents. The enclosure design also provides room for connections and protective conduits.

Level sensors

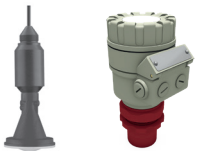

Radar or ultrasonic level sensor



Pressure level sensor

The Kanalis system may be combined with any type of external level sensor via the analogue input of the transmitter.

An ultrasonic level sensor operates by energizing a piezoelectric transducer with an electronic pulse. This pulse creates a pressure wave that travels to the flow surface and is partially reflected back to the transducer. The signal time of flight to the flow surface and back is recorded. The actual distance is calculated knowing the speed of sound at the site, which is corrected by an embedded temperature sensor. Alternatively, the system can be equipped with an external radar water level sensor, which is independent of ambient air temperature.

For channels of depth up to 10 m, the hydrostatic depth sensor (pressure transducer) may be the preferred choice of level measurement.

Technical data

Transmitter

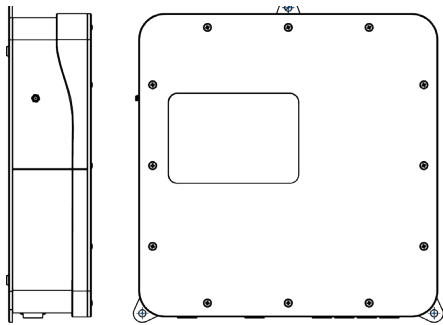

Kanalis

Acoustic paths	1 to 10 (more upon request)
Channel width	1 to 20 m
Accuracy	± 2 % (typical, depending on number of installed paths)
Display	4 lines, 20 characters
Keyboard	4 keys
Data logger	16 GB MicroSD card
Communication	RS-485, Modbus RTU/TCP, Wireless LAN, Ethernet 10/100 Mbps, 4G (LTE) / 3G (HSPA+) / 2G
Inputs	max. 4 x 4-20 mA, 2 x digital
Outputs	max. 4 x 4-20 mA, 4 x Relay, 2 x Pulse
Power supply	9-36 V DC or 100-240 V AC (50/60 Hz)
Approval	IP65 (NEMA 4)
Enclosure	ABS, wall mounted
Dimensions	338 mm x 333 mm x 92 mm (L x W x H)

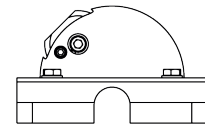
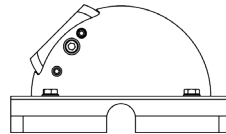

Sensors

TD-200/8

TD-200/18

Frequency	200 kHz	200 kHz
Beam width	8° [-3 dB]	18° [-3 dB]
Channel width	1 to 20 m	1 to 5 m
Accuracy flow	typically ± 2 % of reading, depending on site conditions	typically ± 2 % of reading, depending on site conditions
Material	stainless steel and polyamide	stainless steel and polyamide
Dimensions	∅ 218 mm, height 109 mm	∅ 140 mm, height 70 mm

Kanalis is available with a variety of ultrasonic and radar down-looking level sensors as well as a submersible pressure level sensor. Please consult the separate brochure for further details on the depth sensors.

Headquarter

GWF MessSysteme AG
Obergrundstrasse 119
6005 Lucerne, Switzerland

T +41 41 319 50 50
F +41 41 310 60 87
info@gwf.ch, www.gwf.ch

Sales

GWF Technologies GmbH
Gewerbstraße 46f
87600 Kaufbeuren, Germany

T +49 8341-959990
info@gwf-technologies.de
www.gwf-technologies.de