

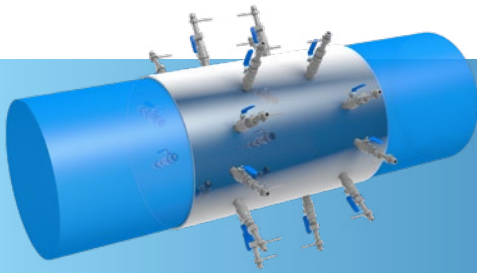

Water



# GWF



## Ductus

Stationary time of flight flowmeter  
for pressurized pipes

### Your benefits

- Up to 10 acoustic measurement paths:  
Exceptional accuracy, repeatability and linearity over the entire measurement range
- Complete installation flexibility:  
Reliable results independent of installation conditions. No straight runs necessary even with 90° elbows, valves, or pumps (swirl)
- Patented velocity profile correction:  
No need for flow straighteners or time-consuming on-site calibration
- Measurement of lowest flows:  
Exact balancing, fast detection of network losses and in-depth understanding of operational processes
- Clamp-on option available:  
Easy and non-intrusive mounting without process interruption guarantees minimal installation costs

### Application

- Pressurized pipes 100-10,000 mm in diameter
- Suitable for sites with difficult installation settings, e.g. pumps, valves or 90° elbows
- Ideal for applications with non-uniform (swirl), rapidly changing or close to zero flow conditions
- Permanent flow monitoring for applications in:
  - Water distribution networks
  - Reservoir monitoring
  - Hydropower plants
  - Wastewater and industry

### Features

- Compact aluminium housing, IP66 (NEMA 4)
- Wetted sensors: Feedthrough or from the inside of the pipe
- Enables measurement of turbine and pump efficiency compliant with IEC 60041 and ASME PTC 18
- Dry sensors: Clamp-on for easy installation, compliant with ISO12242
- Time of flight technology with digital signal processing
- Measurement in multiple planes with single or crossed paths
- U0/D0, no need for flow conditioners or on-site calibration
- Bi-directional measurement over the entire flow range
- Uncertainty down to  $\pm 0.15\%$  of measured flow value
- Zero stability < 1 mm/s, Repeatability <  $\pm 0.02\%$
- Measurement of low velocities down to 1.5 mm/s
- Integrated Wi-Fi access point
- Graphical user interface in multiple languages
- All units for display and data storage can be customized by the user
- Multiple analog and digital outputs, user programmable
- Communication: Ethernet, Modbus RTU/TCP, optional 4G/3G/2G modem
- Power supply: 100-240 V AC or 9-36 V DC
- Internal data storage 16 GB

### Options

- Feedthrough sensors if pipe can be dewatered for installation
- Internal mount sensors if pipe is only accessible from the inside
- Clamp-on sensors for non-intrusive flow measurement
- 1 to 10 acoustic measurement paths

# Product description

Ductus is a time of flight system designed for highly accurate flow measurement in water distribution networks and hydropower plants.

Flow monitoring is very often mandatory in the area of water supply and industry. Quite frequently, the pipe systems are complex and contain valves and pumps. Due to the patented velocity profile compensation of GWF's Ductus, no flow straighteners or on-site calibration are required. The unique digital signal processing allows the detection of even the smallest time differences, i.e. even the smallest amounts are determined accurately.

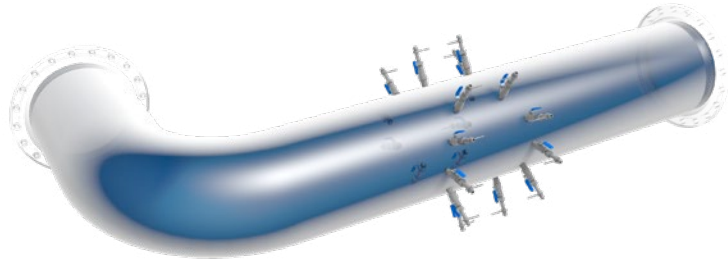

Ductus installed after a 90° elbow

Ductus is a fully integrated metering solution with up to 10 acoustic paths for liquid fluids. It increases your profitability with exceptional repeatability and linearity throughout the flow range.

## WebUI (Wi-Fi)

Ductus is equipped with an integrated web server running a WebUI. You can display and manage the WebUI using the standard web browser of your smartphone, tablet, PC or notebook. There is no need for any additional software or App. Parameter setting and data visualization has never been so easy.



## Measuring principle

Space constraints and application configurations lead to complex flows in pipes which contain elbows, tees or other disturbing and non-uniform elements. This leads to difficulties in installing flowmeters at an optimum location; which is defined by a minimum distance upstream or downstream of known disturbances at which a fully developed velocity profile is present. For traditional flowmeters, significant errors may be caused by these adverse installation conditions.

In contrast to conventional systems, Ductus provides detailed information on the flow velocity profile. An accurate measurement of the flow rate can be achieved by replicating the flow velocity profile across the pipe. Accuracy is maximized using predetermined conduit configuration parameters and correction factors, which incorporate the specific local installation conditions.

Conventional flowmeters are also sensitive to velocity profiles with a large rotational component (swirl). Swirl can be caused by pumps or multiple out-of-plane changes in flow direction. It is present to some extent in almost every application and can generate significant transverse velocity components; and it takes a long distance to dissipate. If the swirl is not accounted for, it can cause significant errors. Ductus can quantify and correct these disrupting factors without difficulty. The Ductus system keeps its measurement accuracy even when asymmetric profiles and swirls are present in the flow.

## Transducer replacement

In the unlikely event that a transducer should fail, Ductus can be programmed to automatically compensate for the loss in path information with little reduced accuracy. Additionally, the operator is advised that an alarm is present.

The feedthrough transducer housings are separated from the transducers themselves and are designed to allow removal of the entire sensor for repair, replacement, or cleaning without the need to dewater the pipe or shut down the process.

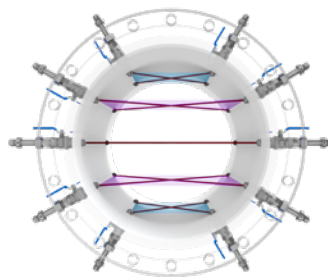

Wetted sensors arranged in five parallel planes

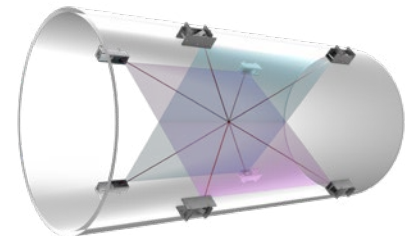

Clamp-on sensors arranged in two 45° planes

# Component description

---

The Ductus system is composed of a wall-mounted transmitter and several sensor options. For non-intrusive measurement, clamp-on transducers are available. If the pipe can be dewatered for installation, feedthrough or internally mounted sensors are suitable options. For multi-path systems, a separate housing to connect up to 20 transducers is available.

## Transmitter

---



Standard transmitter



Multi-path extension housing

The Ductus transmitter incorporates all the required algorithms and software to ensure measurement accuracy and repeatability. The IP66 (NEMA 4X) compact housing features a 4 x 20 alphanumeric LCD display and a 4 button keypad.

All configuration data as well as measured and calculated data are stored inside a 16 GB MicroSD card. The transmitter controls the measurements, calculates the flow rate and provides freely programmable current outputs, status alarms, frequency outputs and totalizer readings.

The Ductus standard transmitter accommodates 2 acoustic paths. For systems with up to 10 measurement paths, an extension housing is available

## Clamp-on transducers

---



CO-L, clamp-on sensor 200 kHz



CO-S, clamp-on sensor 1 MHz

When combining the Ductus with clamp-on transducers, the flow measurement becomes non-intrusive. The transducers are installed with little technical effort and without process interruption on the pipeline. This non-invasive measurement method is suitable for various media such as wastewater, salt water and glycol.

Clamp-on transducers require no modification of the conduit or plant shutdown. Once the CO-L sensors have been installed, they can easily be removed from the mounting system, for example to renew the coupling paste. This prevents a shift of the installation position.

## Wetted sensors

---



FT-S and FT-L feedthrough sensors

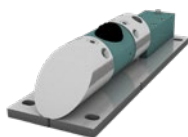

Internal mount sensor TD-IM

Depending on your individual requirements, several options of feedthrough sensors are available. For the sensor type FT-S the pipe only needs to be dewatered for the initial installation. Removal of these sensors for cleaning, repair or replacement is possible without process interruption.

If the pipe is accessible only from the inside, internally mounted sensors are a suitable option.

# Technical data

## Transmitter

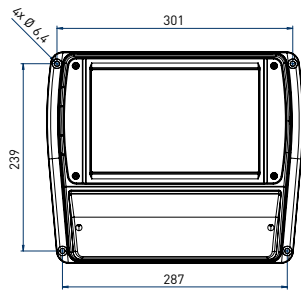
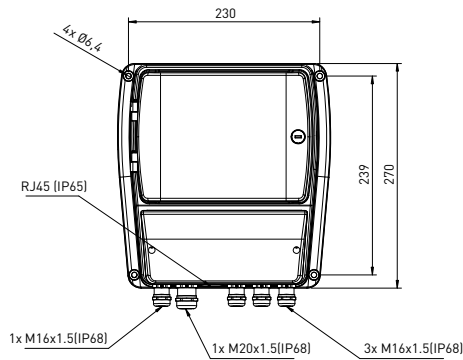

## Ductus

Range	0 to ± 20 m/s
Repeatability	< ± 0.02 %
Zero stability	< 1 mm/s
Data logger	16 GB MicroSD card
Communication	RS-485 or RS-232, Modbus RTU/TCP, Wireless LAN, 4G (LTE) / 3G (HSPA+) / 2G, Ethernet 10/100 Mbps
Inputs	max. 4 x 4-20 mA, 2 x digital
Outputs	max. 4 x 4-20 mA, 4 x relay, 2x digital
Power supply	9-36 V DC or 100-240 V AC (50/60 Hz)
Approval	IP66 (NEMA 4)
Enclosure	Aluminium
Operating temperature	-20 °C to +60 °C
Dimensions	270 x 256 x 139 mm (L x W x H)

## Ductus multi-path extension

Acoustic paths	3 to 10
Power supply	9-36 V DC
Enclosure	Aluminium
Operating temperature	-20 °C to +60 °C
Dimensions	301 x 270 x 118 mm (L x W x H)

## Wetted sensors

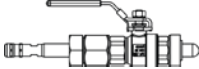
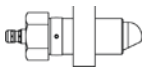
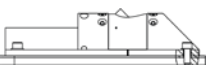
	FT-S 	FT-L1000 	TD-IM 
Frequency	1 MHz	1 MHz	200 kHz
Beam width	5° (-3 dB)	10° (-3 dB)	18° (-3 dB)
Pipe diameter	0.1 m to 2 m	0.3 m to 5 m	1.0 m to 10 m
Uncertainty velocity	up to ± 0.15 % of reading (10 paths)	up to ± 0.15 % of reading (10 paths)	up to ± 0.15 % of reading (10 paths)
Pressure rate	20 bar (other on request)	20 or 40 bar	60 bar
Material	stainless steel	stainless steel	stainless steel / polyamide
Operating temperature	0 °C to +40 °C	0 °C to +40 °C	0 °C to +40 °C
Dimensions	Ø 1", length: 293 mm	Ø 1 1/2", length: 186 mm	320 x 100 x 70 mm (L x W x H)
Installation	ball valve and welding socket	welding socket or thread	from the inside

## Clamp-on transducers

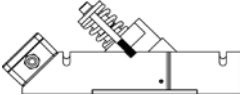
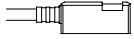
	CO-L 	CO-S 
Pipe diameter	0.4 m to 15 m	0.025 m to 1 m
Pipe wall thickness	up to 100 mm (steel, plastic, glass fiber)	up to 25 mm
Uncertainty velocity	up to ± 0.5 % of reading	up to ± 0.5 % of reading
Frequency, Beam width	200 kHz, 8° (-3 dB)	1 MHz, 5°
Material	stainless steel, POM	stainless steel
Operating temperature	-20 °C to +60 °C	-20 °C to +60 °C
Dimensions	270 x 115 x 100 mm (L x W x H)	56 x 32 x 25 mm (L x W x H)

### Headquarter

GWF MessSysteme AG  
Obergrundstrasse 119  
6005 Lucerne, Switzerland

T +41 41 319 50 50  
info@gwf.ch, www.gwf.ch

### Sales

GWF Technologies GmbH  
Gewerbestraße 46f  
87600 Kaufbeuren, Germany

T +49 8341-959990  
info@gwf-technologies.de  
www.gwf-technologies.de